

# *Vizzybell*

## **Innovation In Safety**



## Specification Guide for the Vizzybell Running Man Series

Maintained Interactive EXIT signage

[www.Vizzybell.com](http://www.Vizzybell.com)

Maintained Interactive Running Man Signage

Product Overview:

---

The Vizybell Running Man series is a new innovative contemporary emergency EXIT sign. As well as it being a conventional exit sign, it is also capable of interacting with an analogue addressable alarm system that will automatically change the unit from Green EXIT state, indicating a safe path of egress, to a flashing Red EXIT state, indicating that the escape route is no longer available due to a possible fire.

The Vizybell Running Man series has been designed to comply with the building code whereby conventional methods are installed as 'alternative solutions' utilising two separate units fail to do so.

The Running Man series has a sleek contemporary design to suit the most modern fitouts and is simple and easy to install in both a ceiling or wall mount application

Product Specifications:

---

Operating Mode	Maintained
Power Supply	230 – 240V AC 50Hz
Max Power Consumption	4W maximum
Battery specification	12V – 1.8 ah Ni-cad/Ni-MH
Lens Material	Acrylic
Sign Housing Material	Extruded Aluminium
Control Box Construction	Injection Moulded Polycarbonate
Product Weight	4.15 KG total (Sign 2.48kg)
Complies with	AS2293.1:2005 Emergency Lighting AS/NZS 60598.2.22 Luminaries For Emergency Lighting

## Maintained Interactive Running Man Signage

- Ceiling or wall mounted options
- Replaces 2 conventional unit with 1 to reduce installation and ongoing compliance costs
- Suitable for retrofitting as well as new build applications
- 3-hour battery life
- Simple connection from the fire alarm panel to change from EXIT green state to EXIT flashing red state during a fire situation
- Manufactured in New Zealand
- Environmentally friendly
- Easy installation
- Battery test switch
- LED indicator to indicated mains power is on
  - RED** indicates Battery is charging
  - GREEN** Indicated Mains power is present, and battery is fully charged
  - Amber** indicates a fault

Maintained Interactive Running Man Signage

Wiring Diagram to be used as a conventional exit sign:

100% Output wiring diagram (Maintained Type)

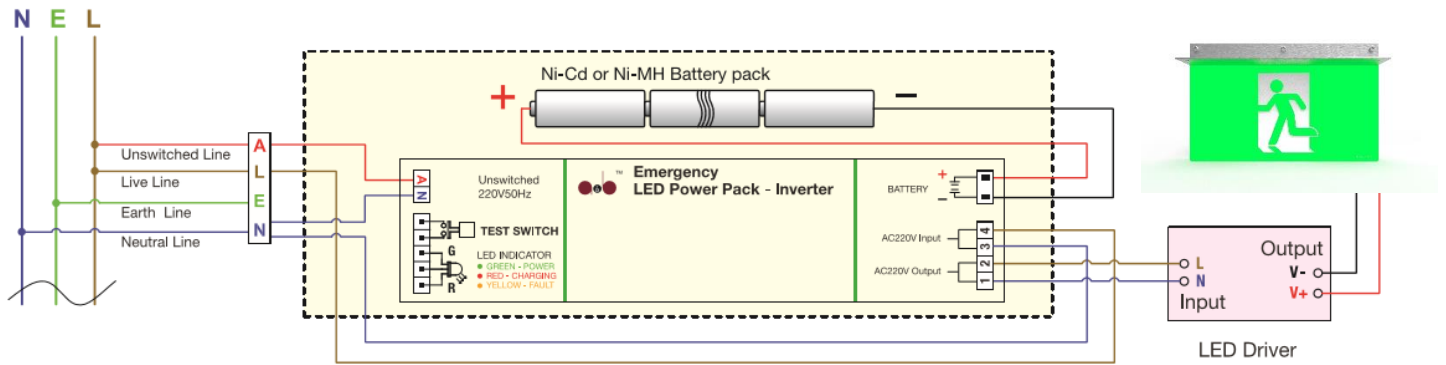

Wiring Diagram to be used as inter-changing state with input from the fire alarm

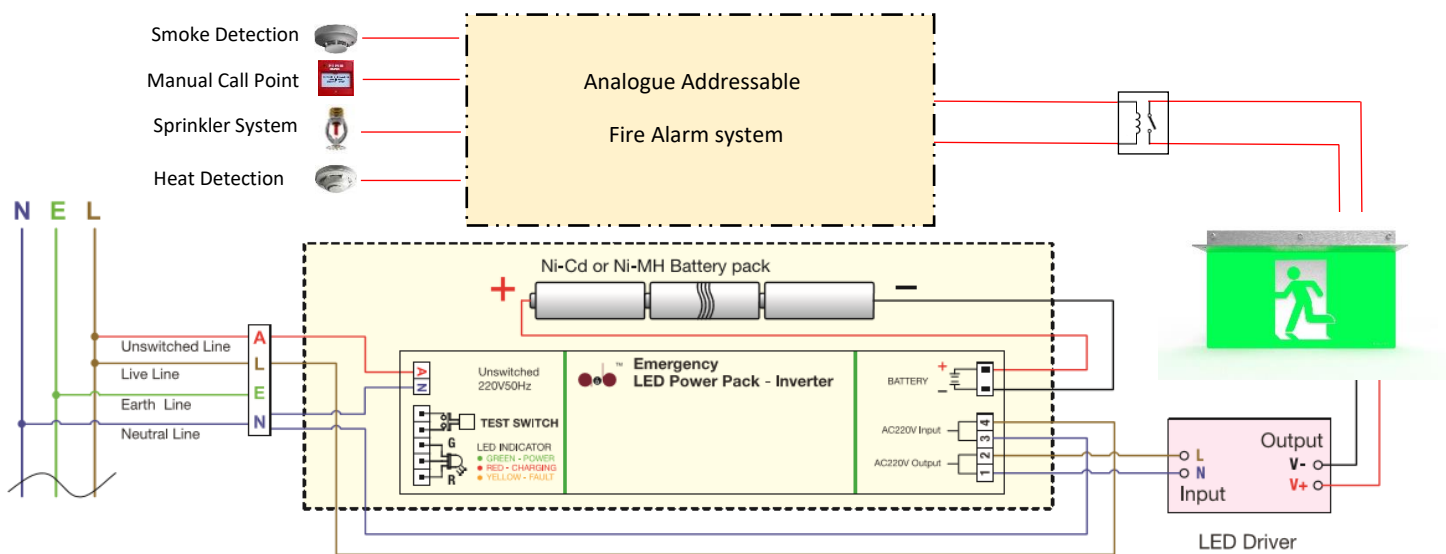

## Maintained Interactive Running Man Signage

### Applications:

---

Any building utilising stage evacuation practices *including but not limited to:*

- Hospitals
- Aged care facilities
- Prisons
- Schools
- Theatres
- Many more

### Included:

---

- Running Man acrylic sign
- Ceiling face plate
- Control box including
  - Test switch
  - Fire alarm relay connection
  - 3 pin plug for ease of installation

### Optional extras:

---

- Wall mounting bracket
- New Battery

Running Man Series By:

**Vizzybell**

Maintained Interactive Running Man Signage

## Product Dimensions:

---



## Notes:

---

This is a class 2 unit  and must be installed by a suitable qualified person in accordance with the installation instruction which are obtainable at [www.Vizzybell.com](http://www.Vizzybell.com)

Please note the installer of this product is responsible for ensuring that it is fit for purpose and meets the requirements of all applicable codes and standards.

For all other information including an installation guide please visit the website as sated below

[www.Vizzybell.com](http://www.Vizzybell.com)

Running Man Series By:

**Vizzybell**

Maintained Interactive Running Man Signage

The Full Range:

Running Man only: P/N VBRUN

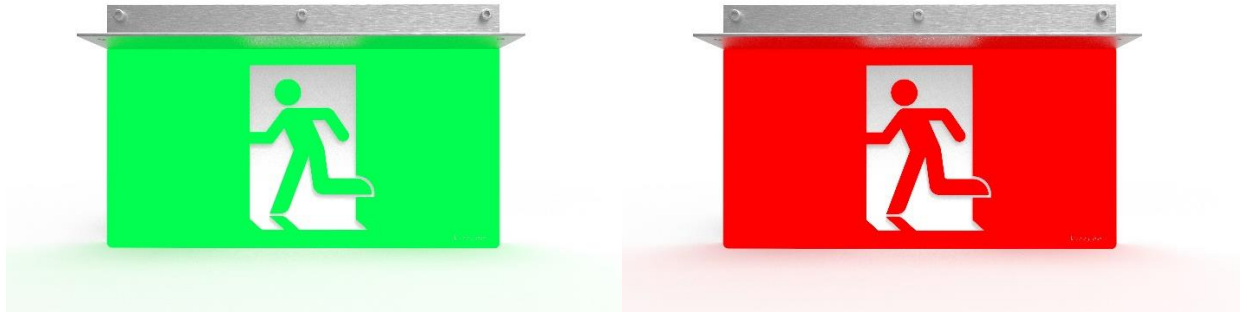

Running Man R/H Arrow: P/N VBRUNR

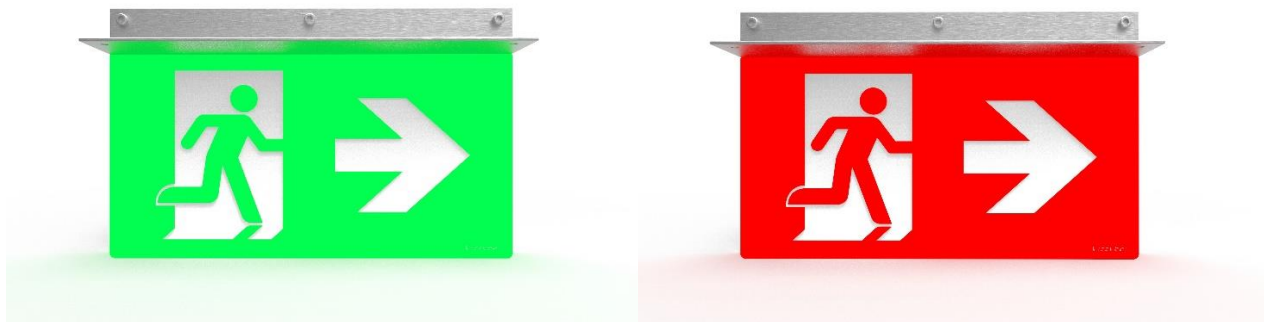

Running Man L/H Arrow: P/N VBRUNL

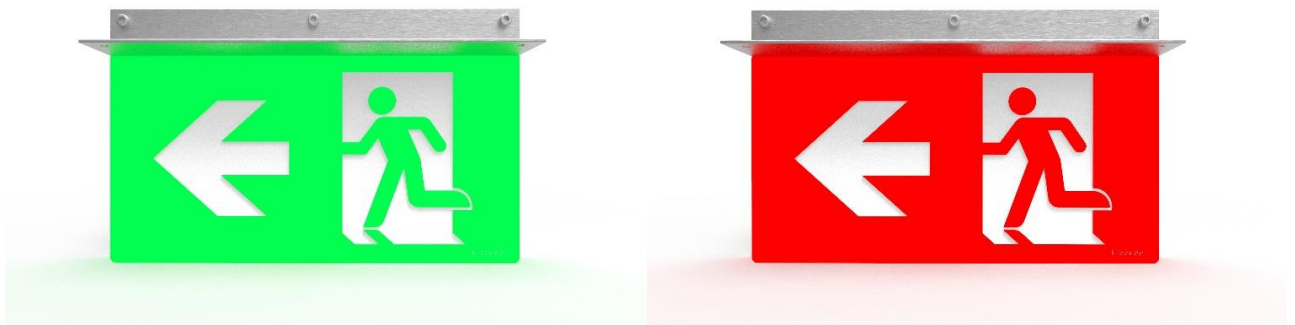

Running Man L/H Down Arrow: P/N VBRUNLD

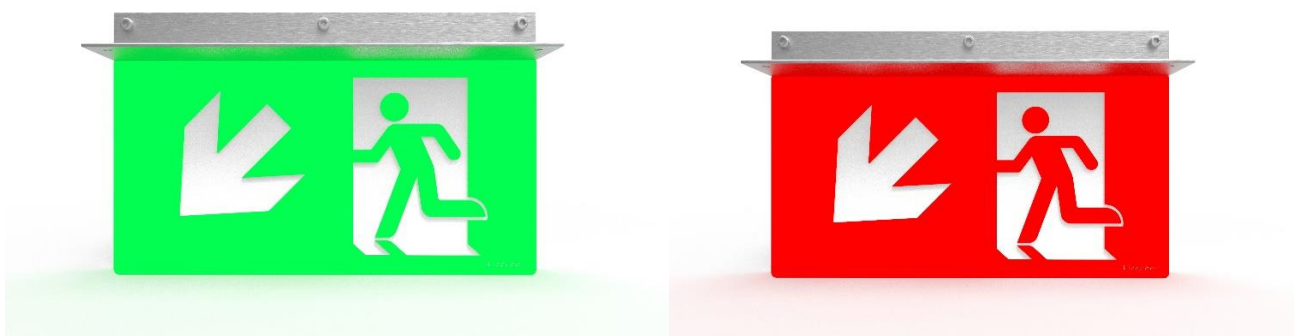

Running Man Series By:

**Vizybell**

Maintained Interactive Running Man Signage

Running Man L/H Down Arrow: P/N VBRUNRD

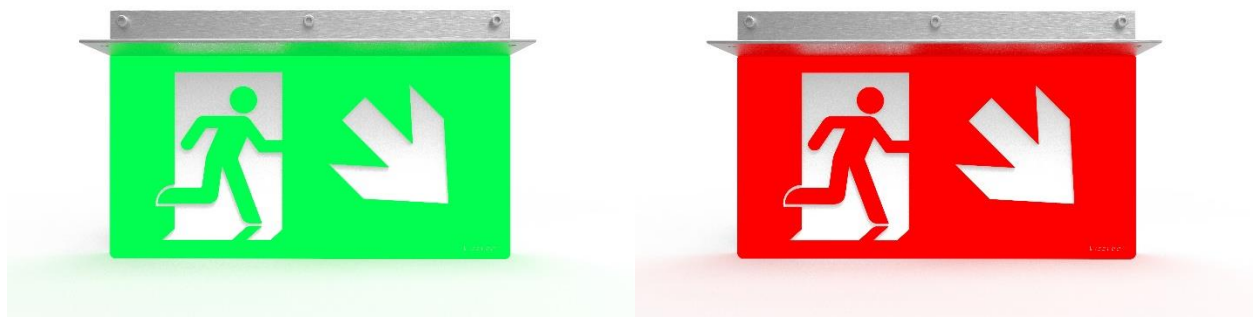

Running Man L/H Down Arrow: P/N VBRUN (B)

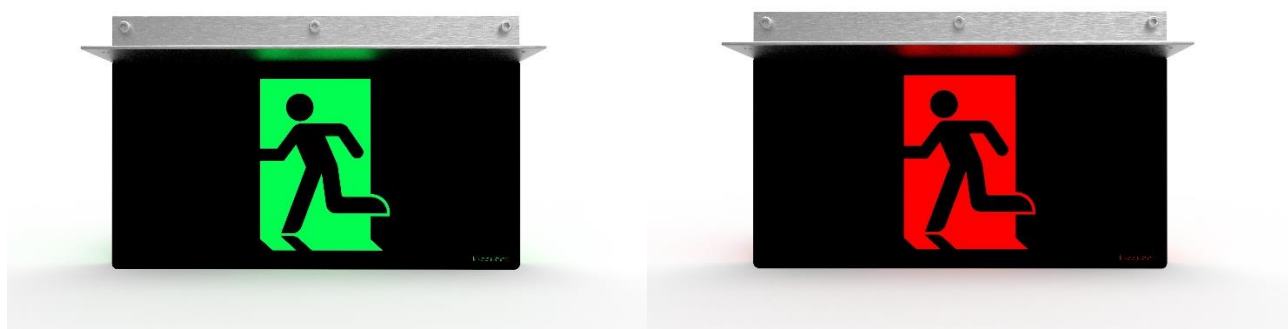

The full range above also come with a black background with the forefront in Green that will change to Red  
(Just add a (B) to the end of the P/N)

Thanks for taking the time to review Vizybell Running Man series

[www.Vizybell.com](http://www.Vizybell.com)